

# Bi-Directional Triode Thyristor

## Power Pac™ Triacs

6A to 15A RMS Up to 600 Volts

Isolated and Non-Isolated Tab

<b>ISOLATED TAB</b>
<b>SC140</b>
<b>SC142</b>
<b>SC147</b>
<b>NON- ISOLATED TAB</b>
<b>SC141</b>
<b>SC143</b>
<b>SC146</b>
<b>SC149</b>
<b>SC151</b>

A triac is a solid state silicon AC switch which may be gate triggered from an OFF-State to an ON-State for either polarity of applied voltage.

POWER PAC™ triacs are molded silicone encapsulated devices which incorporate General Electric's patented POWER GLAS™ glassivation process. This process provides an intimate bond between the silicon chip and the glass coating, significantly improving device performance and reliability. The copper mounting surface on the isolated tab types is electrically insulated from the silicon chip and the three electrical terminal leads.

**FEATURES:**

- POWER-GLAS™ passivated silicon chip for maximum reliability.
- Very low off-state (leakage) current at room and elevated temperatures.
- Inherent immunity from non-repetitive transient voltage damage (max. critical rate-of-rise of on-state current subsequent to voltage breakover triggering,  $di/dt = 10 \text{ A}/\mu\text{sec.}$ ).
- Low on-state voltage at high current levels.
- Excellent surge current capability.
- 1600 volts RMS Surge Isolation Voltage on Isolated Triacs.
- Selected types available from factory for use where circuit requires operation:
  - with popular zero voltage triggering IC's
  - at 400 Hz
  - with low gate trigger current
  - at higher voltage levels
  - at higher commutating  $dv/dt$  levels

**POWER PAC PACKAGE**

- Meets JEDEC TO-220AB specifications.
- Round leads – greatly simplifies assembly.
- Six standard lead forming configurations available from factory (including TO-66 compatibility.)

- Rugged, industry-proven packaging.

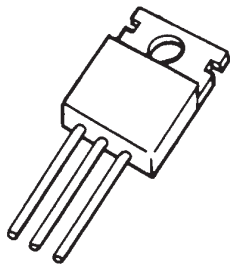

ISOLATED (RED)

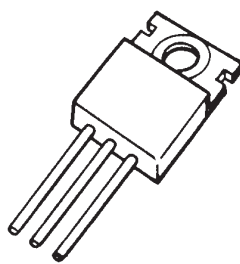

NON-ISOLATED (BLUE)

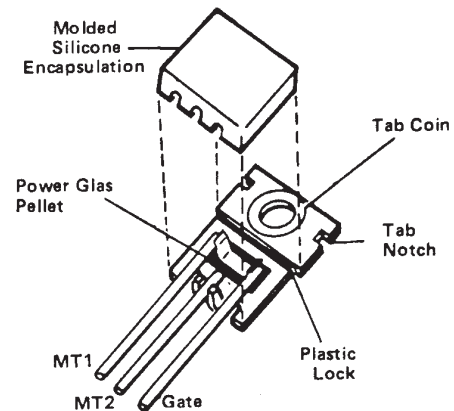

PICTORIAL ASSEMBLY

ISOLATED TAB	NON-ISOLATED TAB
SC140, 2, 7	SC141, 3, 6, 9, SC151

MAXIMUM ALLOWABLE RATINGS

TYPE	RMS ON-STATE CURRENT $I_T(RMS)^{(1)}$ AMPERES	REPETITIVE PEAK OFF-STATE VOLTAGE, $V_{DRM}^{(2)}$				PEAK ONE FULL CYCLE SURGE (NON-REP) ON-STATE CURRENT, $I_{TSM}$ AMPERES		$I^2t$ FOR FUSING FOR TIMES AT(3)	
		B	D	E	M	50 Hz	60 Hz	(RMS AMPERE) <sup>2</sup> SECONDS 1.0 MILLISECOND	(RMS AMPERE) <sup>2</sup> SECONDS 8.3 MILLISECONDS
		VOLTS	VOLTS	VOLTS	VOLTS	AMPERES	AMPERES		
<b>ISOLATED TAB</b>									
SC140	6.5	200	400	500	600	74	80	18	26.5
SC142	8	200	400	500	600	104	110	20	50
SC147	10	200	400	500	600	104	110	20	50
<b>NON-ISOLATED TAB</b>									
SC141	6	200	400	500	600	74	80	18	26.5
SC143	8	200	400	500	600	110	120	20	60
SC146	10	200	400	500	600	110	120	20	60
SC149	12	200	400	500	600	110	120	20	60
SC151	15	200	400	500	600	110	120	20	60

Peak Gate Power Dissipation,  $P_{GM}$  (4) ..... 10 Watts for 10 Microseconds (See Chart 4)  
Average Gate Power Dissipation,  $P_{G(AV)}$  ..... 0.5 Watts  
Peak Gate Current,  $I_{GM}$  (4) ..... See Chart 4  
Peak Gate Voltage,  $V_{GM}$  (4) ..... See Chart 4  
Storage Temperature,  $T_{stg}$  ..... -40°C to +125°C  
Operating Temperature,  $T_J$  ..... -40°C to +100°C  
Surge Isolation Voltage (5) ..... 1600 Volts RMS

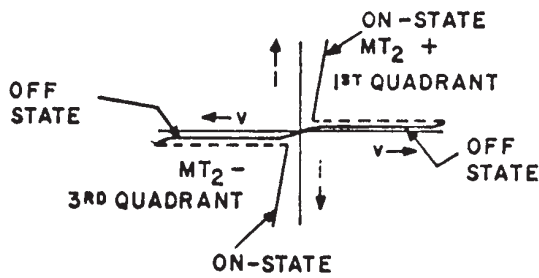

TYPICAL CHARACTERISTICS  
VOLT-AMPERES



TERMINAL ARRANGEMENT

NOTES:

- At the case reference point (see outline drawing) temperature of 80°C maximum (except 75°C maximum for SC142 and SC149) and 360° conduction.
- Ratings apply for zero gate voltage only. Ratings apply for either polarity of main terminal 2 voltage referenced to main terminal 1.
- Ratings apply for either polarity of main terminal 2 referenced to main terminal 1.
- Ratings apply for either polarity of gate terminal referenced to main terminal 1.
- Isolated tab triacs only. Rating applies from main terminals 1 and 2 and gate terminal to device mounting surface. Test voltage is 50 or 60 Hz sinusoidal wave form applied for one minute. Rating applies over the entire device operating temperature range.

ISOLATED TAB	NON-ISOLATED TAB
SC140, 2, 7	SC141, 3, 6, 9, SC151

CHARACTERISTICS

TEST	SYMBOL	MIN.	TYP.	MAX.	UNITS	TEST CONDITIONS	REF. NOTE			
Repetitive Peak Off-State Current	$I_{DRM}$				mA	$V_{DRM}$ = Maximum Allowable Repetitive Off-State Voltage Rating Gate Open Circuited	1			
		-	-	0.1		$T_C = +25^\circ C$				
		-	-	0.5		$T_C = +100^\circ C$				
Peak On-State Voltage	$V_{TM}$				Volts	$T_C = +25^\circ C$ , $I_{TM} = 1$ msec., Wide Pulse, Duty Cycle $\leq 2\%$	1			
SC140	-	-	1.85	$I_{TM} = 9.2$ A Peak						
SC141	-	-	1.83	$I_{TM} = 8.5$ A Peak						
SC142	-	-	1.75	$I_{TM} = 11.5$ A Peak						
SC143	-	-	1.55	$I_{TM} = 11.5$ A Peak						
SC146	-	-	1.65	$I_{TM} = 14$ A Peak						
SC147	-	-	1.50	$I_{TM} = 14$ A Peak						
SC149	-	-	1.65	$I_{TM} = 17$ A Peak						
SC151	-	-	1.52	$I_{TM} = 21$ A Peak						
Critical Rate-of-Rise of Off-State Voltage (Higher values may cause device switching)	$dv/dt$				Volts/ $\mu$ sec	$T_C = +100^\circ C$ , Rated $V_{DRM}$ Gate Open Circuited Exponential Voltage Waveform	1			
SC140, SC141	30	100	-							
SC142, SC143	50	150	-							
SC146, SC147	100	150	-							
SC149	100	200	-							
SC151	100	250	-							
Critical Rate-of-Rise of Commutating Off-State Voltage (Commutating $dv/dt$ )	$dv/dt(c)$	4	-	-	Volts/ $\mu$ sec	$I_{T(RMS)}$ = Rated Maximum Allowable RMS On-State Current, $V_{DRM}$ = Maximum Rated Peak Off-State Voltage, Gate Open Circuited.	1, 4			
DC Gate Trigger Current	$I_{GT}$					mAdc		$V_D = 12$ Vdc	2	
		-	-	50			$+25^\circ C$			
		-	-	50	TRIGGER MODE			$R_L$		$T_C$
		-	-	50	MT2+ Gate +			100 Ohms		
		-	-	80	MT2- Gate -		100 Ohms			
		-	-	80	MT2+ Gate -		50 Ohms	$-40^\circ C$		
		-	-	80	MT2+ Gate +		50 Ohms			
		-	-	80	MT2- Gate -		50 Ohms			
	-	-	80	MT2+ Gate -	25 Ohms					
DC Gate Trigger Voltage	$V_{GT}$				Vdc	$V_D = 12$ Vdc	2			
		-	-	2.5				$+25^\circ C$		
		-	-	2.5		TRIGGER MODE			$R_L$	$T_C$
		-	-	2.5		MT2+ Gate +			100 Ohms	
		-	-	2.5		MT2- Gate -		100 Ohms		
		-	-	3.5		MT2+ Gate -		50 Ohms	$-40^\circ C$	
		-	-	3.5		MT2+ Gate +		50 Ohms		
		-	-	3.5		MT2- Gate -		50 Ohms		
	-	-	3.5	MT2+ Gate -	25 Ohms					
DC Gate Non-Trigger Voltage	$V_{GD}$	0.2	-	-	Vdc	TRIGGER MODE	$R_L$	$T_C$	2, 3	
						MT2+ Gate +	1000 Ohms	$+100^\circ C$		
						MT2- Gate -				
						MT2+ Gate -				
				MT2- Gate +						

ISOLATED TAB	NON-ISOLATED TAB
SC140, 2, 7	SC141, 3, 6, 9, SC151

CHARACTERISTICS (Continued)

TEST	SYMBOL	MIN.	TYP.	MAX.	UNITS	TEST CONDITIONS	REF. NOTE		
DC Holding Current	$I_H$				mAdc	Main Terminal Source Voltage = 24 Vdc Peak Initiating On-State Current = 0.5A, 0.1 milliseconds to 10 milliseconds wide pulse, Gate Trigger Source = 7V, 20 Ohms.	1		
		-	-	50				$T_C = +25^\circ\text{C}$	
		-	-	100				$T_C = -40^\circ\text{C}$	
DC Latching Current	$I_L$				mAdc	Main Terminal Source Voltage = 24 Vdc Gate Trigger Source = 15V, 100 Ohms, 50μsec pulse width, 5 μsec rise and fall times maximum	2		
		-	-	100					
		-	-	100					
		-	-	200					
		-	-	200					
		-	-	200					
		-	-	400					
Steady State Thermal Resistance	$R_{\theta JA}$	-	-	75	$^\circ\text{C/Watt}$	Junction-to-Ambient	1, 5		
Steady State Thermal Resistance	$R_{\theta JC}$				$^\circ\text{C/Watt}$	Junction-to-Case This characteristic is useful as an acceptance test at an incoming in- spection station.	1, 6		
SC140	-	-	3.1						
SC141	-	-	3.0						
SC142	-	-	3.3						
SC143	-	-	3.2						
SC146	-	-	2.2						
SC147	-	-	2.5						
SC149	-	-	2.0						
SC151	-	-	2.0						
Apparent Thermal Resistance	$R_{\theta JC(ac)}$				$^\circ\text{C/Watt}$	Junction-to-Case This characteristic is useful in the calculation of junction temperature rise above case temperature for AC current conduction.	7		
SC140	-	-	2.04						
SC141	-	-	2.22						
SC142	-	-	2.31						
SC143	-	-	1.97						
SC146	-	-	1.50						
SC147	-	-	1.69						
SC149	-	-	1.52						
SC151	-	-	1.10						

NOTES:

1. Characteristic values apply for either polarity of main terminal 2 referenced to main terminal 1.
2. Main terminal 1 is the reference terminal for main terminal 2 and gate terminal.
3. With  $V_D$  equal to maximum allowable off-state voltage.
4. Values for these test conditions are:

Device	Commutating di/dt	$T_C$
SC140	3.5 A/msec	+80°C
SC141	3.2 A/msec	+80°C
SC142	4.3 A/msec	+75°C
SC143	4.3 A/msec	+80°C
SC146 / SC147	5.4 A/msec	+80°C
SC149	6.4 A/msec	+75°C
SC151	8.1 A/msec	+80°C

5. The junction-to-ambient value is under worst case conditions; i.e., with No. 22 copper wire used for electrical contact to the terminals and natural convection cooling.

6. Junction-to-case steady-state thermal resistance ( $R_{\theta JC}$ ) is tested in accordance with EIA-NEMA Standard RS-397, Section 3.3.2, which states: "Thermal characteristics are to be measured with the device operating in only one direction." The values listed are the limiting value for either direction. For non-isolated devices, the MT2 lead temperature reference point is approximately equal to the case temperature reference point (see outline drawing).
7. Apparent thermal resistance applies for a 50 or 60 Hz full sine wave of current. It can be calculated with the following formula:

$$\text{Apparent thermal resistance} = \frac{T_{J(\max)} - T_C}{P_{T(AV)}}$$

where:  $T_{J(\max)}$  = maximum junction temperature  
 $T_C$  = case temperature  
 $P_{T(AV)}$  = average on-state power

See Reference Chart 12.

ISOLATED TAB	NON-ISOLATED TAB
SC140, 2, 7	SC141, 3, 6, 9, SC151

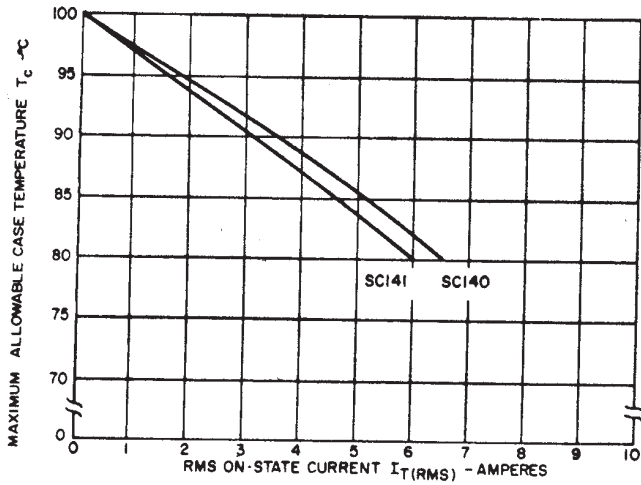

SC140 / SC141

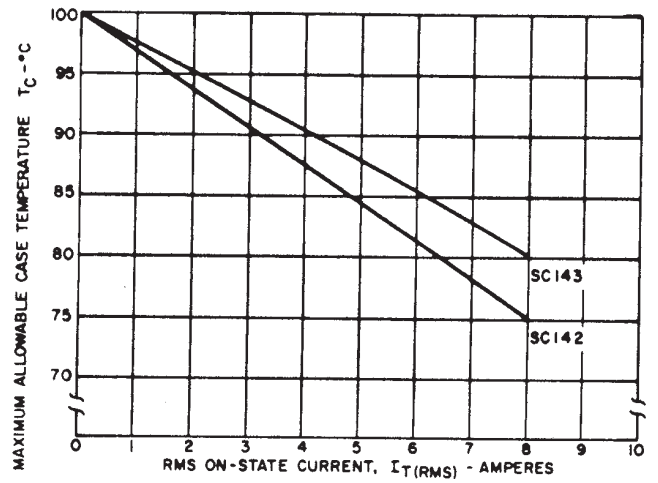

SC142 / SC143

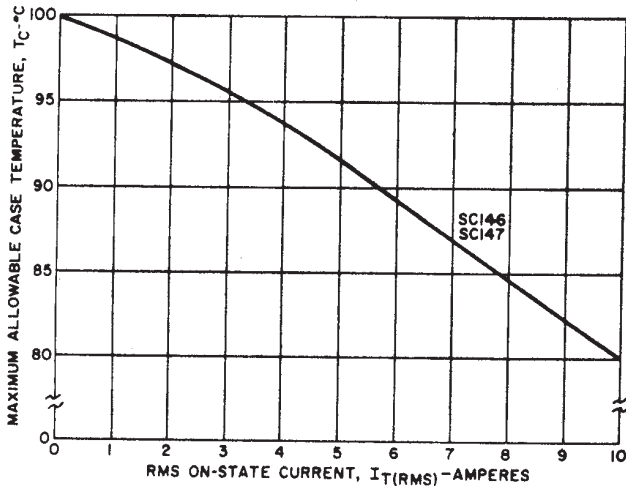

SC146 / SC147

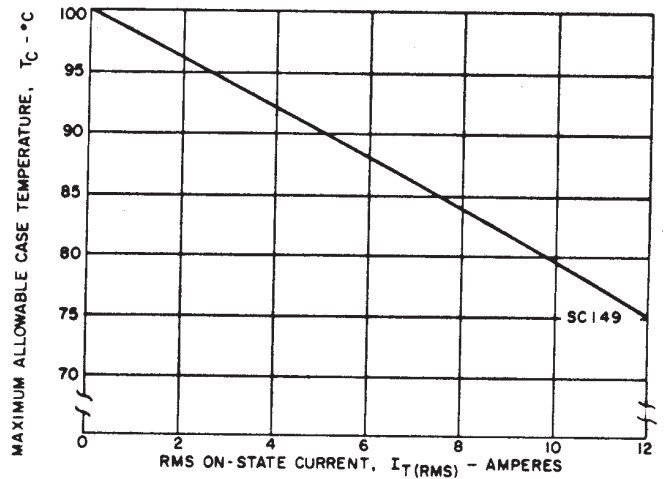

SC149

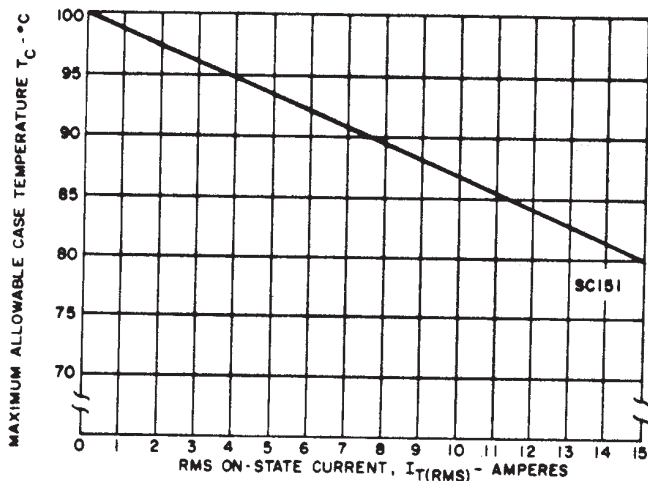

SC151

NOTES:

1. Case temperature measurement point is shown on outline drawings.
2. Rating curves apply for 50 or 60 Hz sine wave operation.
3. Conduction angle = 360°.

1. MAXIMUM CURRENT RATINGS

ISOLATED TAB	NON-ISOLATED TAB
SC140, 2, 7	SC141, 3, 6, 9, SC151

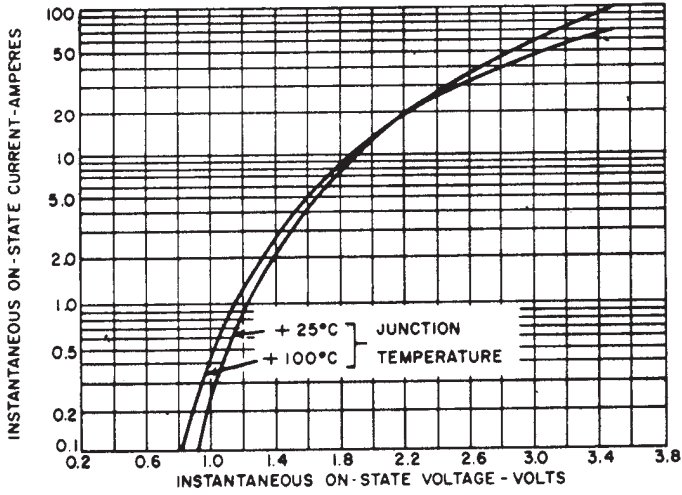

SC140 / SC141

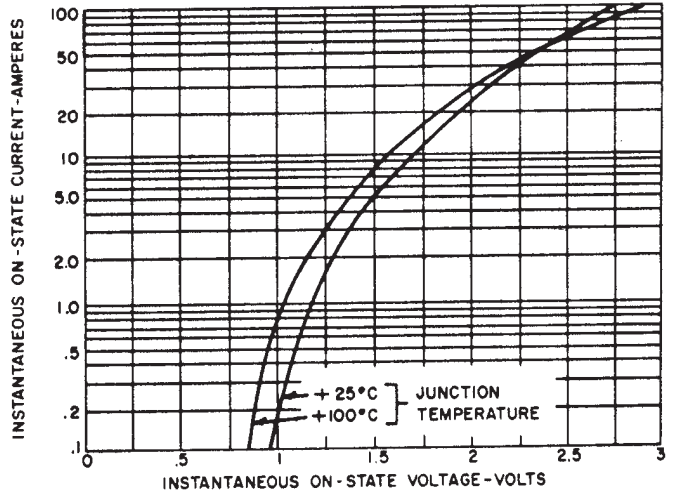

SC142

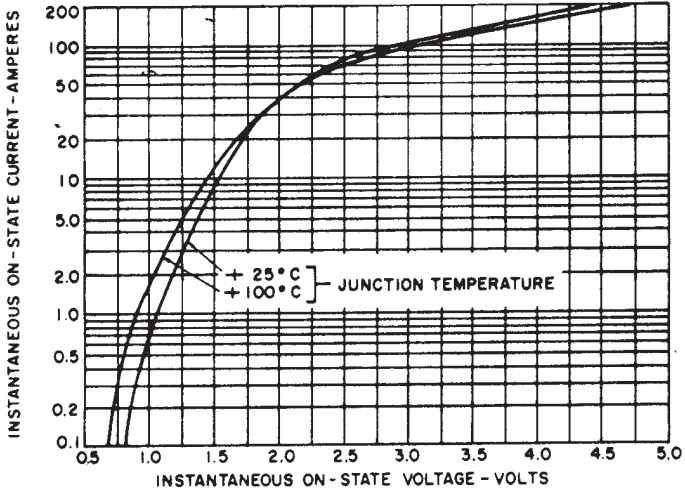

SC143 / SC146 / SC149

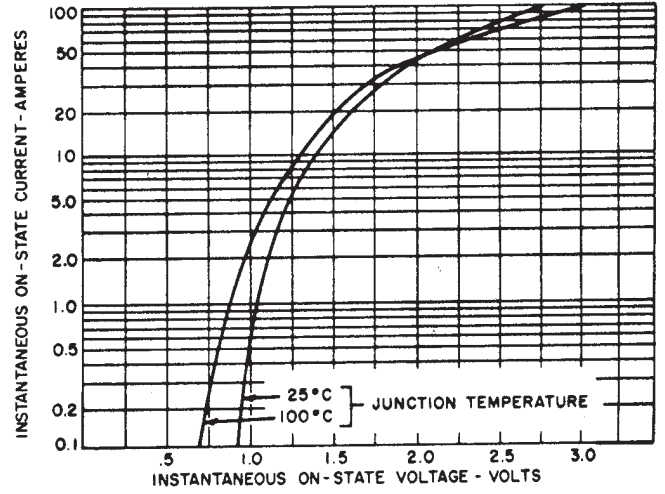

SC147

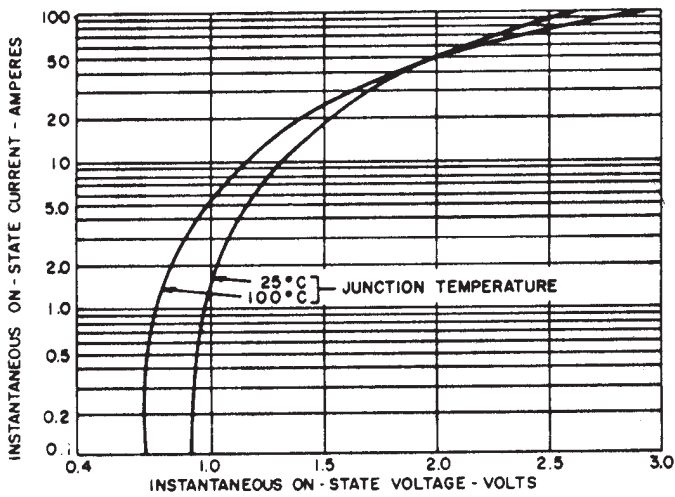

SC151

NOTES:

1.  $I_{TM} = 1$  msec. pulse, duty cycle 2%.
2. Curves apply for either polarity of main terminal 2 referenced to main terminal 1.

2. MAXIMUM ON-STATE CHARACTERISTICS

ISOLATED TAB	NON-ISOLATED TAB
SC140, 2, 7	SC141, 3, 6, 9, SC151

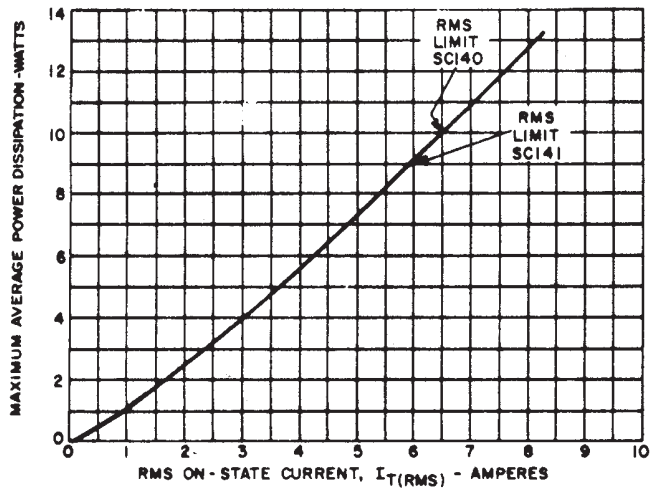

SC140 / SC141

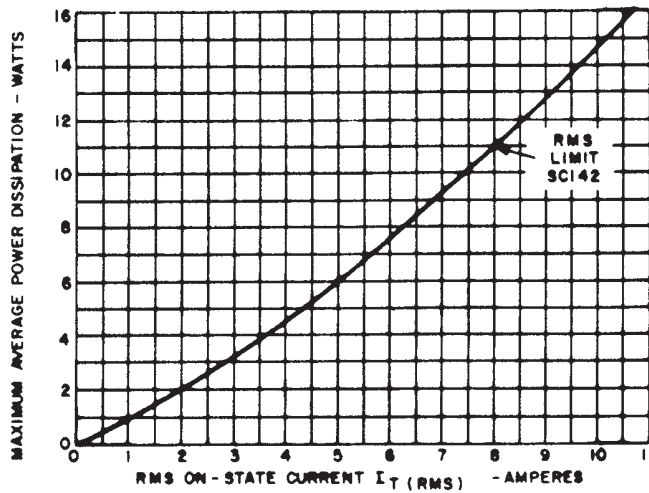

SC142

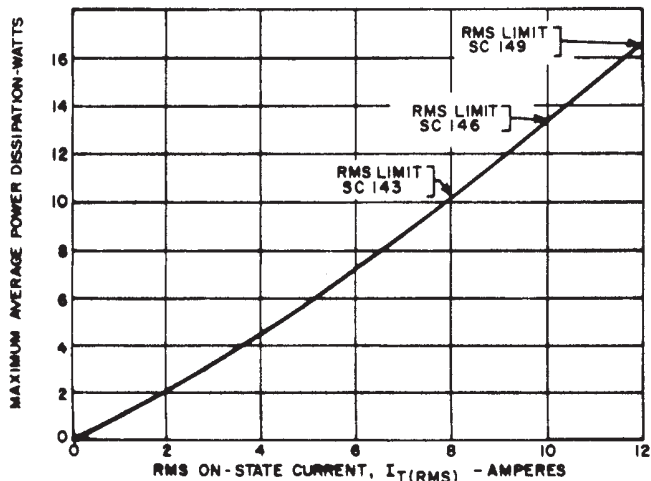

SC143 / SC146 / SC149

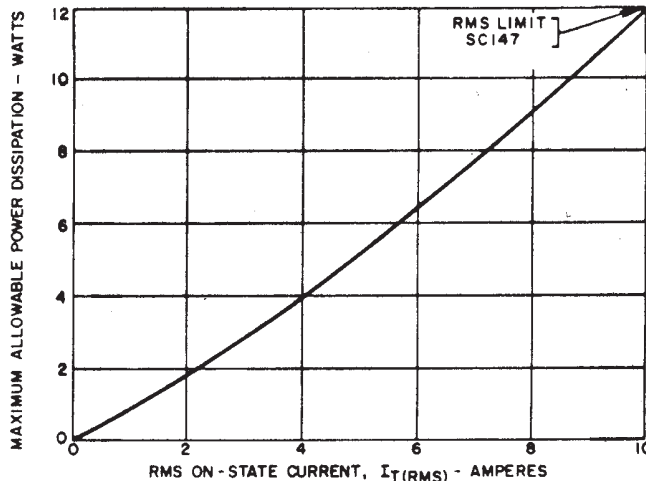

SC147

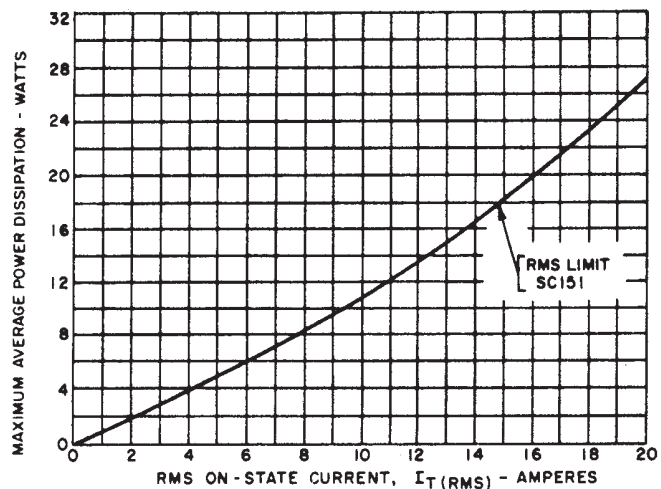

SC151

NOTES:

1.  $T_J = 100^\circ\text{C}$ .
2. Conduction angle =  $360^\circ$ .
3. Current waveform is sinusoidal, 50 or 60 Hz.

3. MAXIMUM POWER DISSIPATION

ISOLATED TAB	NON-ISOLATED TAB
SC140, 2, 7	SC141, 3, 6, 9, SC151

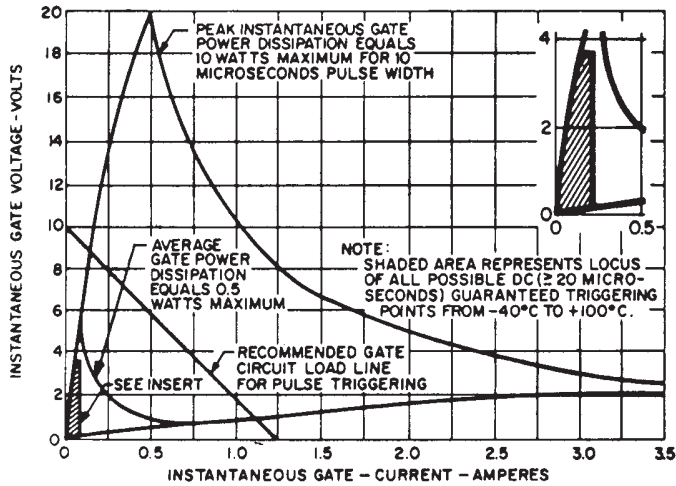

4. GATE CHARACTERISTICS AND RATINGS

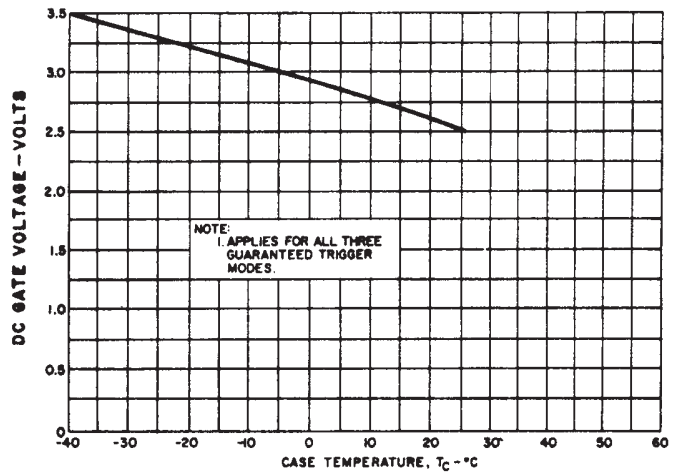

5. MAXIMUM DC GATE VOLTAGE TO TRIGGER VERSUS CASE TEMPERATURE

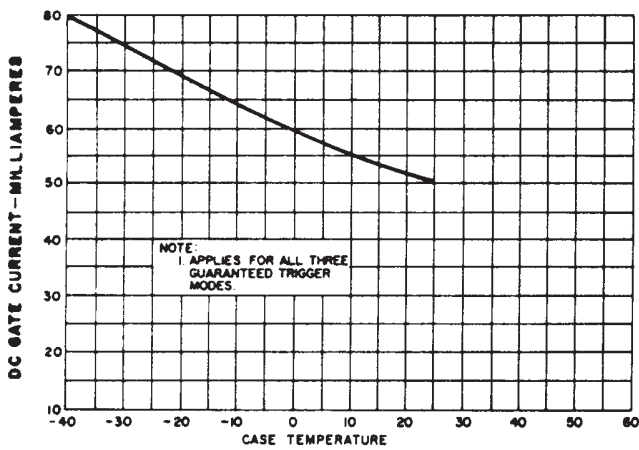

6. MAXIMUM DC GATE CURRENT TO TRIGGER VERSUS CASE TEMPERATURE

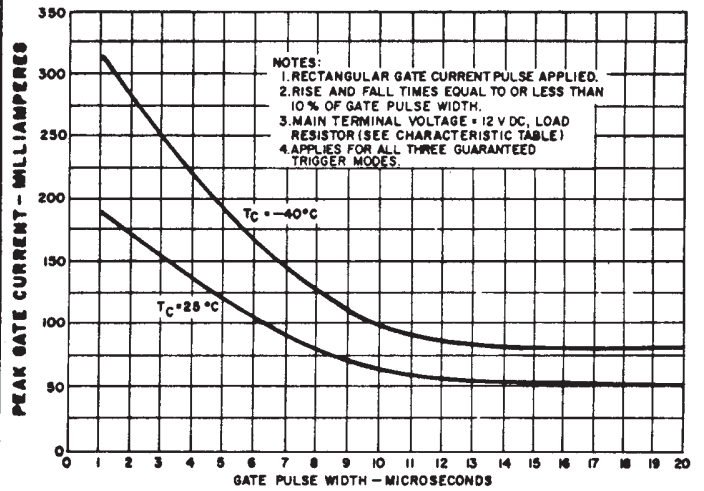

7. MAXIMUM GATE CURRENT TO TRIGGER VERSUS GATE PULSE WIDTH



ISOLATED TAB	NON-ISOLATED TAB
SC140, 2, 7	SC141, 3, 6, 9, SC151

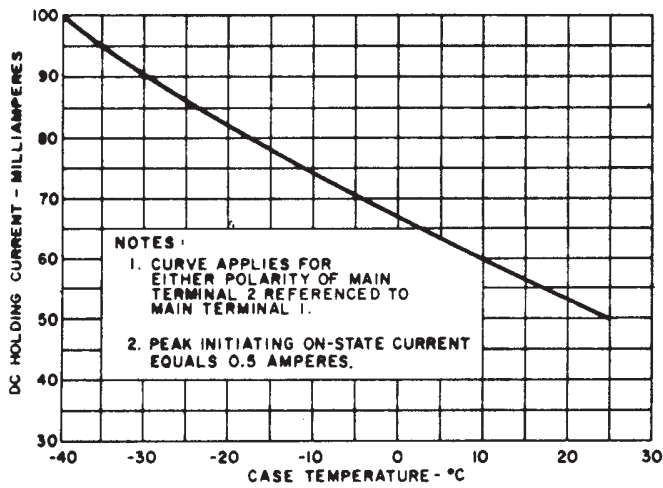

8. MAXIMUM DC HOLDING CURRENT VERSUS CASE TEMPERATURE

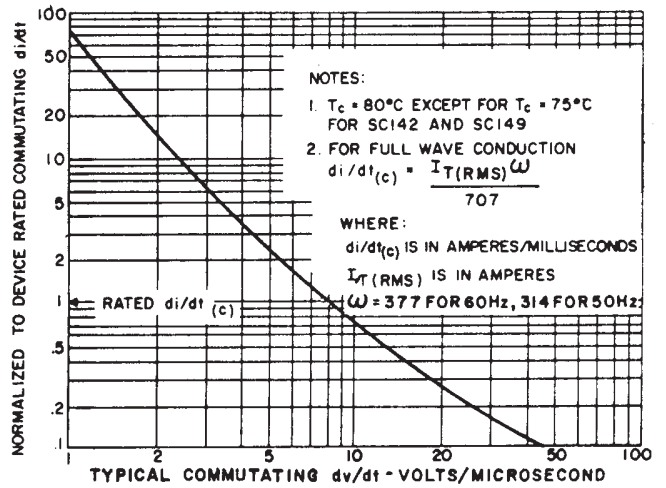

9. NORMALIZED DEVICE RATED COMMUTATING DI/DT VERSUS COMMUTATING DV/DT

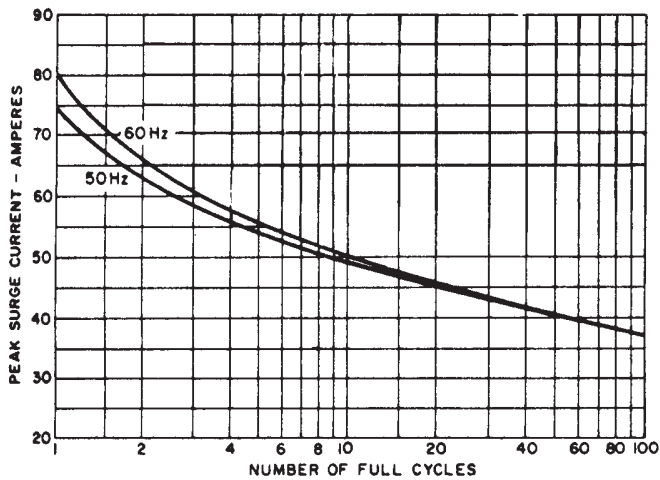

SC140 / SC141

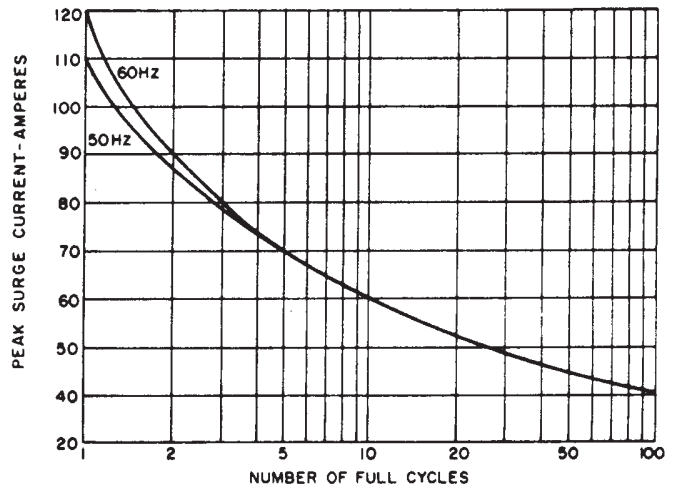

SC143 / SC146 / SC149 / SC151

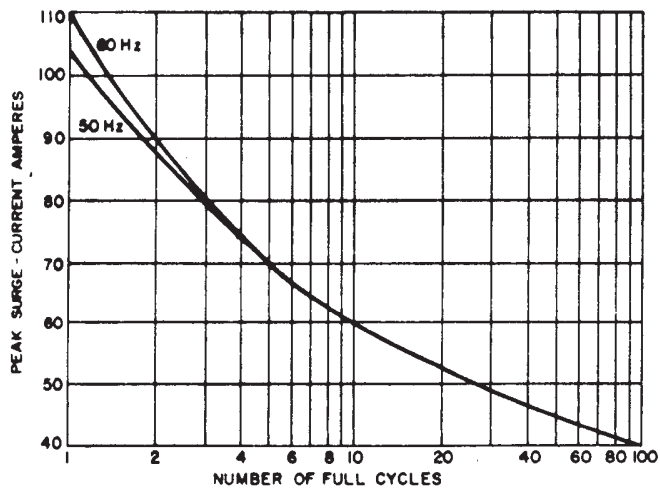

SC142 / SC147

10. MAXIMUM ALLOWABLE PEAK FULL CYCLE SURGE (NON-REPETITIVE) ON-STATE CURRENT

NOTES:

- Gate control may be lost during and immediately following the surge current interval.
- Current surge may not be repeated until junction temperature has returned to within steady-state rated value.
- Junction temperature immediately prior to surge =  $40^\circ\text{C}$  to  $100^\circ\text{C}$ .

ISOLATED TAB	NON-ISOLATED TAB
SC140, 2, 7	SC141, 3, 6, 9, SC151

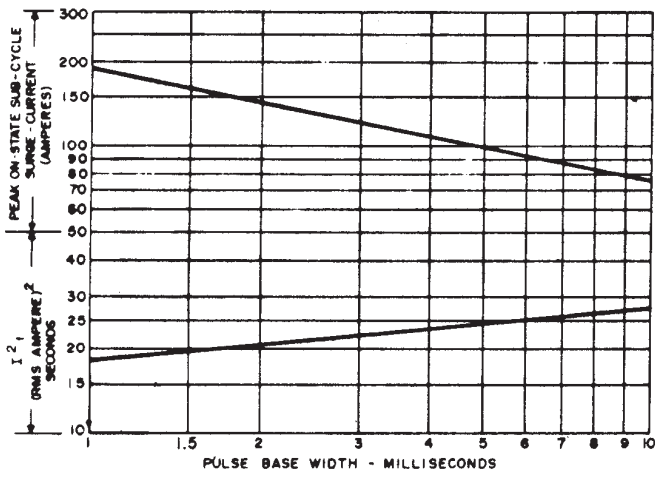

SC140 / SC141

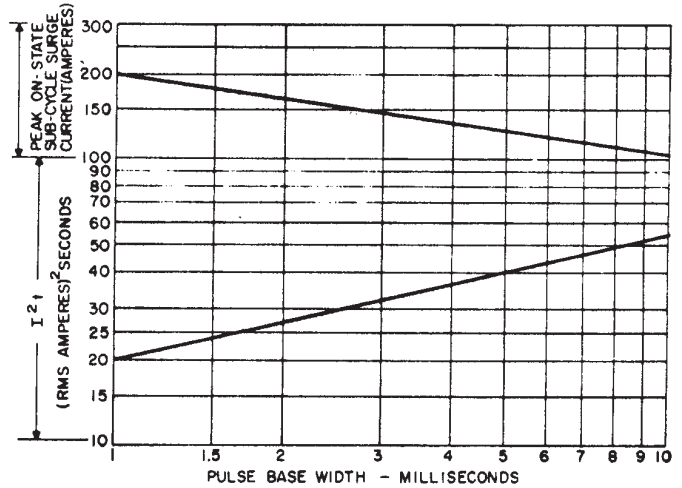

SC142 / SC147

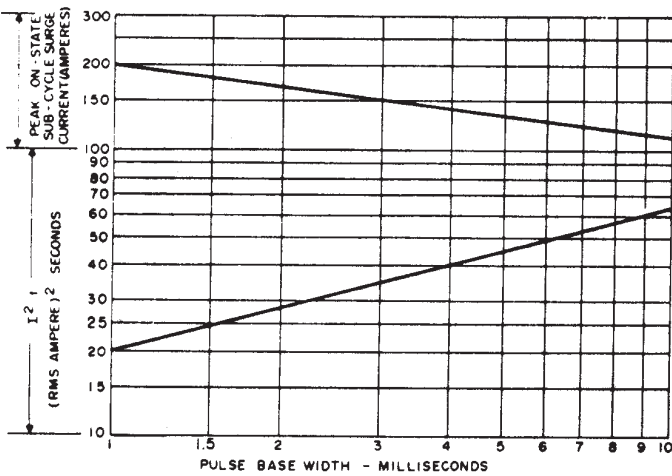

SC143 / SC146 / SC149 / SC151

11. SUBCYCLE SURGE (NON-REPETITIVE) ON-STATE CURRENT AND  $I^2t$  RATINGS

NOTES:

1. Curves apply for either polarity of main terminal 2 referenced to main terminal 1.
2. Curves for half sine wave current waveform.
3. Gate control may be lost during and immediately following the surge current interval.
4. Current surge may not be repeated until junction temperature has returned to within steady-state rated value.
5. Junction temperature immediately prior to surge =  $-40^{\circ}\text{C}$  to  $100^{\circ}\text{C}$ .

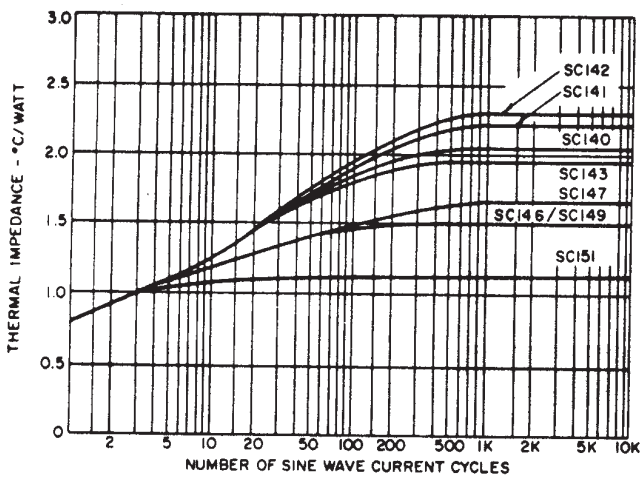

12. MAXIMUM APPARENT TRANSIENT THERMAL IMPEDANCE (50 AND 60 Hz SINE WAVE OPERATION)

NOTES:

1. Curve defines temperature rise of either junction above case temperature for equal amplitudes symmetrical sine wave current at 50 and 60 Hz.
2. Curve considers junction temperature measured immediately after the final cycle of current.
3. Gate will regain control if temperature is maintained below rated value and load current is reduced or maintained at RMS value.
4. For more than 100 cycles of current the case temperature rise must be observed and used in calculating the total junction temperature.
5. Junction temperature rise above case is defined as apparent transient thermal impedance times average conduction power dissipated during full cycle conduction.
6. Apparent steady-state value is not the same as JEDEC value listed as steady-state in characteristics table.

ISOLATED TAB	NON-ISOLATED TAB
SC140, 2, 7	SC141, 3, 6, 9, SC151

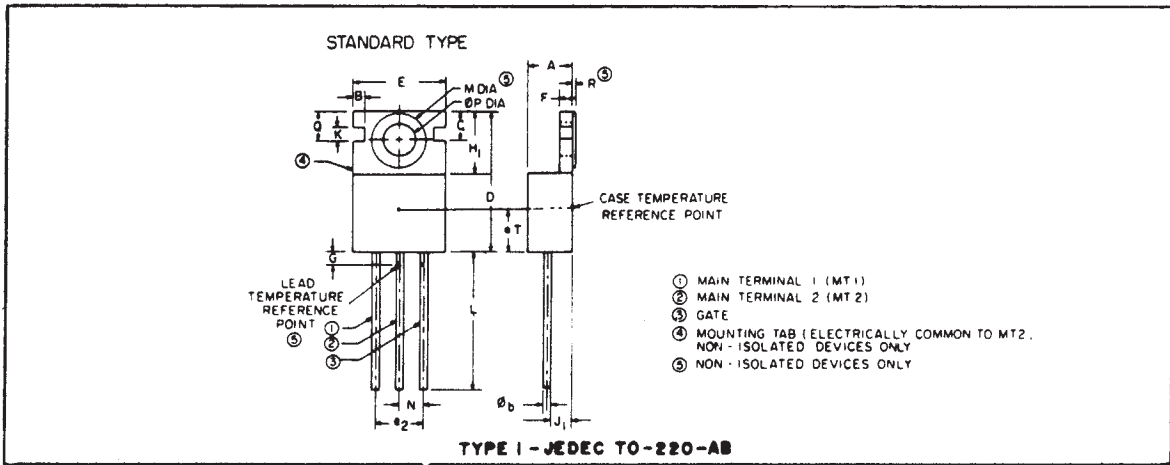

SYMBOL	INCHES		METRIC MM		SYMBOL	INCHES		METRIC MM	
	MIN	MAX	MIN	MAX		MIN	MAX	MIN	MAX
A	.160	.190	4.06	4.83	N	.095	.105	2.41	2.67
B	.054 TYP.		1.37 TYP.		Ø P	.141	.145	3.58	3.68
Ø b	.029	.035	.73	.89	Q	.118 REF.		3.00 REF.	
C	.110	.120	2.79	3.05	R	.0015	.004	—	.10
D	.560	.650	14.23	16.51	S	.570	.590	14.47	14.99
E	.390	.420	9.90	10.67	T	—	.220	—	5.59
Ø 2	.190	.210	4.82	5.33	V	.040	.070	1.01	1.78
F	.040	.055	1.01	1.39	W	.020	.030	.50	.76
G	—	.065	—	1.65	Z	.172	.202	4.36	5.13
H <sub>1</sub>	.240	.260	6.09	6.60	AA	.087	.097	2.20	2.46
J <sub>1</sub>	.085	.115	2.15	2.92	AB	.120	.130	3.04	3.30
K	.054 REF.		1.37 REF.		AC	.025	.035	.63	.89
L	.500	—	12.70	—	AD	.045	.055	1.14	1.40
L <sub>3</sub>	.360	—	9.14	—	AE	.353	.433	8.96	11.00
M	.232	.236	5.89	5.99					

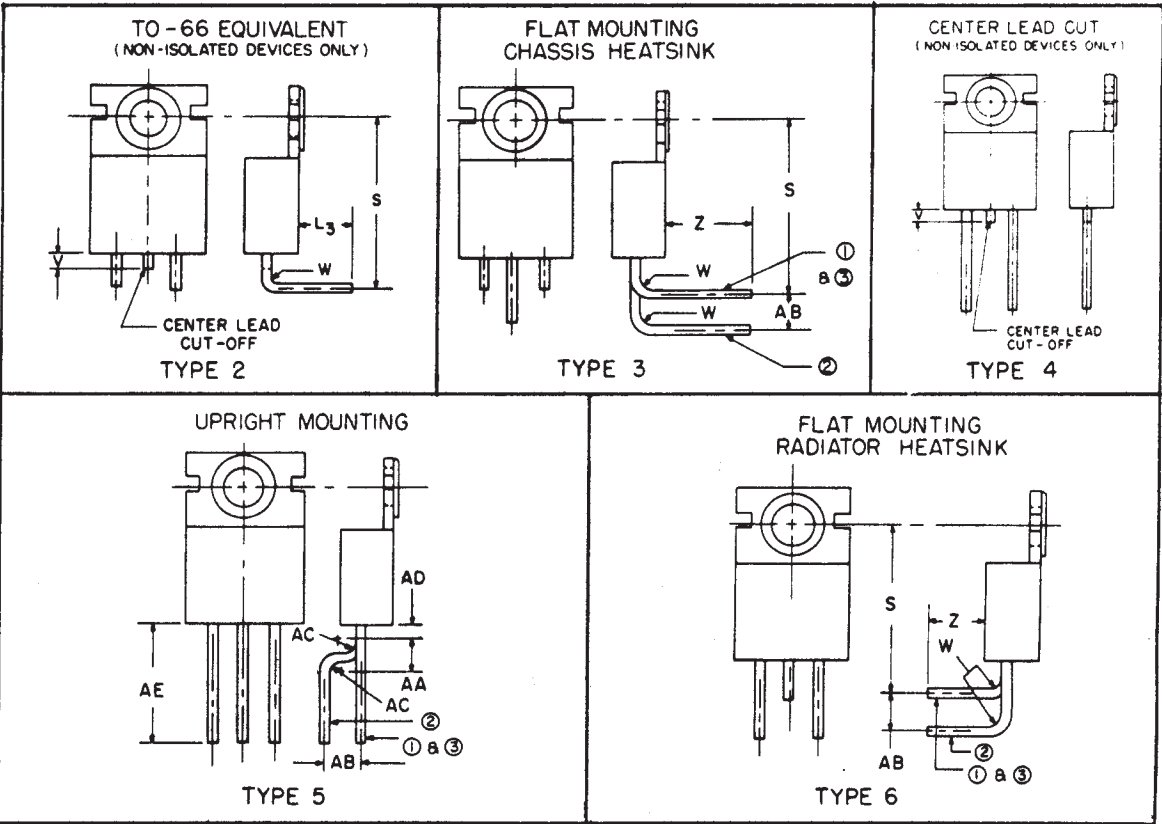

ISOLATED TAB	NON-ISOLATED TAB
SC140, 2, 7	SC141, 3, 6, 9, SC151

POWER PAC TRIAC PART NUMBER DESIGNATION

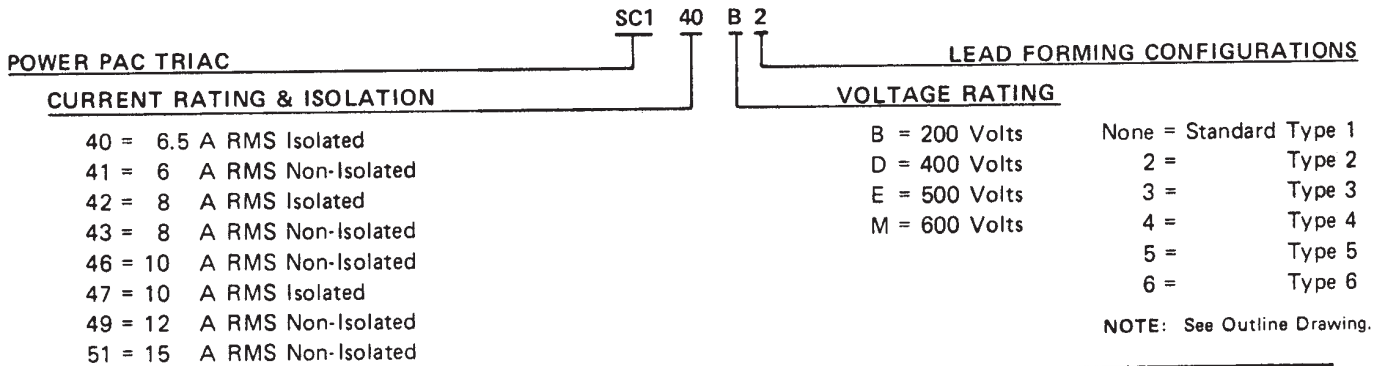

TYPICAL CIRCUITS

Triacs are especially useful in AC lamp dimming because of their ability to conduct in both directions.

The circuit shown here incorporates General Electric's ST4 asymmetrical AC trigger integrated circuit. This device greatly reduces the snap-on effects that are present in symmetrical trigger circuits and minimizes control circuit hysteresis. This performance is possible with a single RC time constant, whereas a symmetrical circuit of comparable performance would require at least three additional passive components.

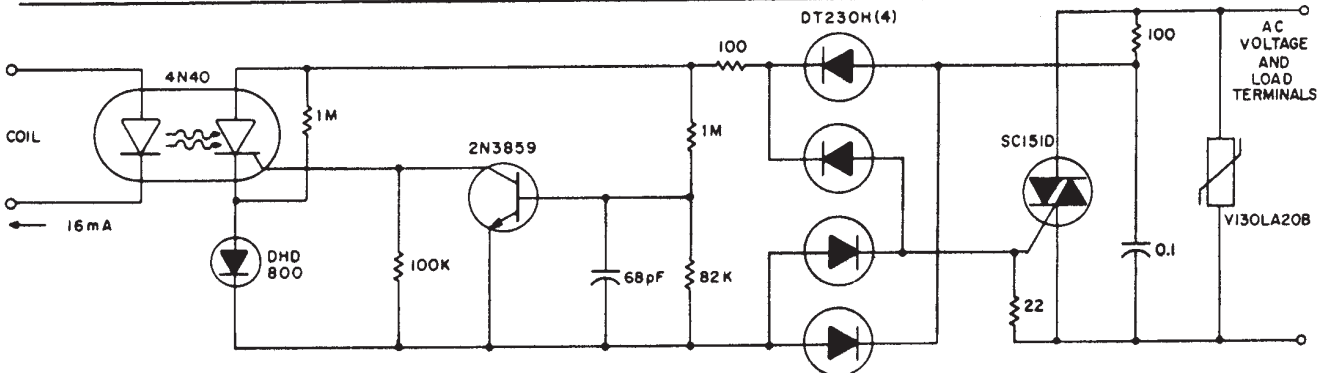
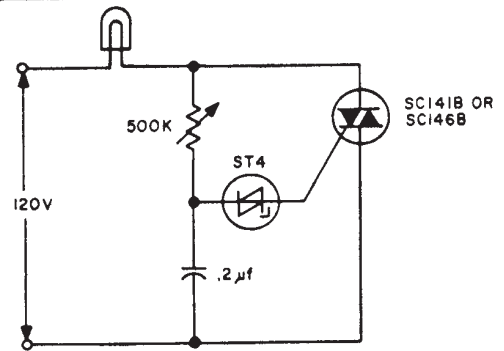

The SC151D, in combination with an optically-isolated SCR (4N40), allows this highly transient immune, TTL compatible, zero voltage switching design for a normally open 15 ampere solid-state relay. Zero voltage crossing is sensed via the base emitter diode drop of the 2N3859 which then allows the 4N40 SCR portion to be triggered and apply gate signal to the SC151 triac. The transient immunity is designed in through use of the GE-MOV®, the snubber network and the choice of 400 volt semiconductors.

OTHER TRIAC, TRIGGER AND APPLICATION INFORMATION AVAILABLE FROM GENERAL ELECTRIC

PUBLICATION NUMBER	TRIAC SPECIFICATION SHEETS	PUBLICATION NUMBER	APPLICATION NOTES
175.13	SC136	200.35	Using the Triac for Control of AC Power
175.34	Hermetic Triacs	200.53	Solid State Incandescent Lighting Controls
	<b>TRIGGER SPECIFICATION SHEETS</b>	201.12	500 Watt AC Line Voltage and Power Regulator
175.30	ST2 (Diac)	201.19	RF Filter Considerations for Triac & SCR Circuits
175.32	ST4 (Asymmetrical AC Trigger)	201.24	Thyristor Selection for Incandescent Lamp Loads
65.32	2N4992 (Silicon Bilateral Switch)	200.55	Thermal Mounting Considerations for Plastic Power Semiconductor Packages
	<b>RELIABILITY REPORT</b>		
95.29	Glassivated Triac Reliability Report		